

Operation Instruction

SR81

Intelligent Controller

for Split Pressurized Solar Hot Water System



Please read this instruction carefully!

INAA

INSTALACIONES NATURALES ALTEA

Contents

1. Safety information	3
1.1 Installation and commissioning	3
1.2 About this manual	3
1.3 Liability waiver	3
1.4 Important information	4
1.5 Signal description	4
1.6 Button and HMI description	4
2. Overview	5
2.1 Technical data	5
2.2 Delivery list	6
3. Installation	6
3.1 Mounting the display of controller	6
3.2 Mounting the board of controller	7
3.3 Preparation before wiring connection	7
3.4 Wiring connection	7
3.5 Terminal connection	8
3.5.1 Terminal allocation of controller for electrical heater of 1500W	8
3.3.2 Terminal allocation of controller for electrical heater of 3000W/4000W	9
4. System description (Standard solar system with 1 tank, 1 collector field)	10
5. Time setup	11
6. Function's parameters and options	12
6.1 Overview of menu structure	12
6.2 Menu operation description	12
6.3 Value checking and function checking	13
7. Functions operation and parameters setting (for user)	13
7.1 Timing heating	13
7.2 CIRC DHW circulation pump controlled by temperature and time	17
8. Function operation and parameter setup (engineer)	22
8.1 PWD Password	22
8.2 LOAD tank heating	22
8.3 COL Collector function	24
8.4 COOL Collector function	28
8.5 AUX Auxiliary function	31

8.6 MAN Manual operation	36
8.7 BLPR Blocking protection	37
8.8 OTDI Thermal Sterilization Function	38
8.9 FS Flow rate monitoring and pump dry-running protection	39
8.10 UNIT C-F Switch	41
8.11 RET Reset	41
8.12 PASS Password set	42
8.13 Manual heating.....	43
8.14 ECO Economic mode.....	43
8.15 DHW circuit pump triggered manually	44
8.16 On/Off controller	44
8.17 Holiday function	44
8.18 Manual circuit function	45
9. Protection function	45
9.1 Memory function during power failure	45
9.2 Screen protection	45
10 Trouble checking	45
11. Quality Guarantee.....	47
12. Accessories	47

1. Safety information

1.1 Installation and commissioning

- When laying wires, please ensure that no damage occurs to any of the constructional fire safety measures presented in the building.
- The controller must not be installed in rooms where easily inflammable gas mixtures are present or may occur.
- The permissible environmental conditions can't be exceeded at the site of installation.
- Before connecting the device, make sure that the energy supply matches the specifications that controller requires.
- All devices connected to the controller must conform to the technical specifications of the controller.
- All operations on an open controller are only to be conducted cleared from the power supply. All safety regulations for working on the power supply are valid.
- Connecting and /or all operations that require opening the collector (e.g. changing the fuse) are only conducted by specialists.

1.2 About this manual

This manual describes the mounting, functions and operation of a solar controller used for a solar hot water system, for mounting of other devices of a completed solar hot water system like solar collector, pump station and storage, please is sure to observe the appropriate installation instructions provided by each manufacturer. Mounting, wire connecting, commissioning and maintenance of this controller may only be performed by the trained professional person; the professional person should be familiar with this manual and follow the instructions contained herein.

1.3 Liability waiver

The manufacturer can't monitor the compliance with these instructions or the circumstances and methods used for installation, operation, utilization and maintenance of this controller. Improper installation can cause damages to material and person. This is the reason why we do not take over responsibility and liability for losses, damages or cost that might arise due to the improper installation, operation or wrong utilization and maintenance or that occurs in some connection with the aforementioned. Moreover we do not take over liability for patent infringements or infringements – occurring in connection with the use of this controller on the third parties rights. The manufacturer preserves the right to put changes to product, technical

data or installation and operation instructions without prior notice. As soon as it becomes evident that safe operation is no longer possible (e.g. visible damage). Please immediately take the device out of operation. Note: ensure that the device can't be accidentally placed into operation.

1.4 Important information

We have carefully checked the text and pictures of this manual and provided the best of our knowledge and ideas, however inevitable errors may exist. Please note that we cannot guarantee that this manual is given in the integrity of image and text, incorrect, incomplete and erroneous information and the resulting damage we do not take responsibility.

1.5 Signal description



Safety indication: Safety instructions in the text are marked with a warning triangle.

They indicate measures which can lead to injury of person or safety risks.

Operation steps: small triangle "▶" is used to indicate operation step.







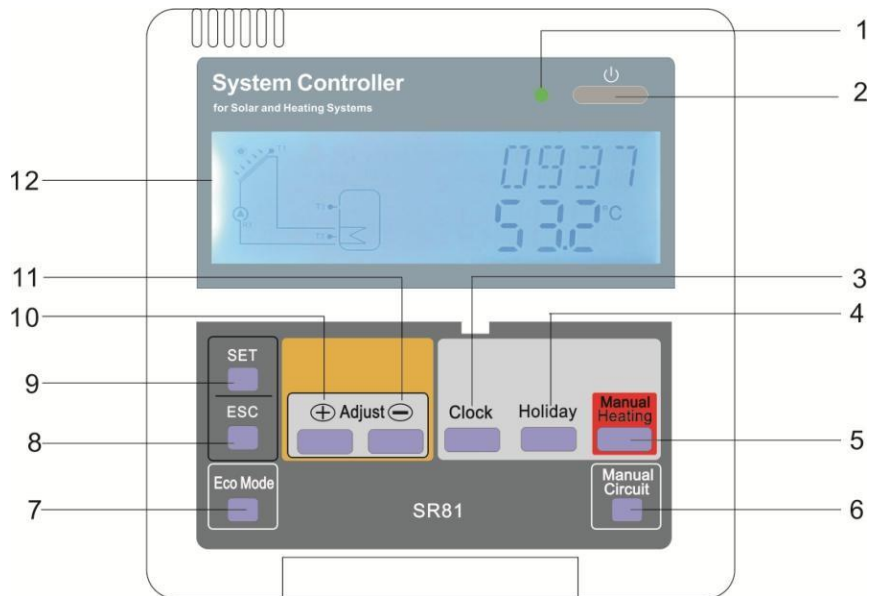



Note: contains important information about operation or functions.

1.6 Button and HMI description



Nr.	Button
1	Power indication lamp
2	"On/Off"
3	"Clock"
4	"Holiday"
5	"Manual Heating"
6	"Manual Circuit"
7	"Eco Mode"
8	"Exit"
9	"Adjust"
10	Upwards adjust "+"
11	Downwards adjust "-"
12	LCD Display screen

Status Description	Code	Lighting	Blinking
Exceed the maximum temperature of storage	SMX		
Running of storage emergency shutdown function			
Running of collector emergency shutdown function	OCEM		 + 
Running of collector cooling	OCCO		
Running of tank cooling function	OSTC		
Start of anti-freezing function	OCFR		
Running of anti-freezing function	OCFR		

2 Overview

2.1 Technical data

- **Power supply:** 100...240V ~(50...60Hz)
- **Rated impulse voltage:** 2.5KV
- **Housing:** Plastic ABS
- **Mounting:** Wall mounting
- **Operation:** 10 push buttons at the front cover

- **Protection type:** IP40
- **1500W or 3000W/4000W of electrical heater should be remarked in the purchased order**
- **Dimension of display:** 120*120*18mm
- **Dimension of controller board with 1500W output:** 200*140*43mm
- **Dimension of controller board with 3000W/4000W output:** 218*165*55mm



Note: there are 4 inputs for NTC10K, B=3950 temperature sensor, but only 2 sensors are included in the standard delivery list; the other two should be purchased separately by customer if necessary.

2.2 Delivery list

- 1 * SR81 controller
- 1 * accessory bag
- 1 * user manual
- 1 * PT1000 temperature sensor ($\phi 6*50\text{mm}$, cable length 1.5meter)
- 2 * NTC10K temperature sensor ($\phi 6*50\text{mm}$, cable length 3meter)
- 1 *10A power cable (Note: controller for 3000W electrical heater has no power cable delivered, user should prepare a cable of 2.5mm^2)

3. Installation



Note: The unit must only be located in the dry interior rooms. Please separate routing of sensor wires and mains wires. Make sure the controller as well as the system is not exposed to strong electromagnetic fields. For control 3000W/4000W electrical heaters, an extra switch should be installed, and 2.5mm^2 cable should be used to connect electrical heater to the terminals of controller.

3.1 Mounting the display of controller

- ▶ Using Screw and turn it, take the display base plate out, see picture 1
- ▶ Fixing the base on the wall with screw (see picture 2), (Note: don't drill hole on the base plate)
- ▶ insert the display into the base plate groove ①②, and press it tightly. See picture 3



3.2 Mounting the board of controller

Follow the below steps to mount the controller on the wall.

- ▶ Select the proper place to install main board of controller
- ▶ Put the hung housing plate on the wall and mark the upper fastening point.
- ▶ Drill the holes and put the plastic expansion bolt into the holes.
- ▶ Hang the housing plate on the screw and fasten it
- ▶ Hang the controller on the housing plate.

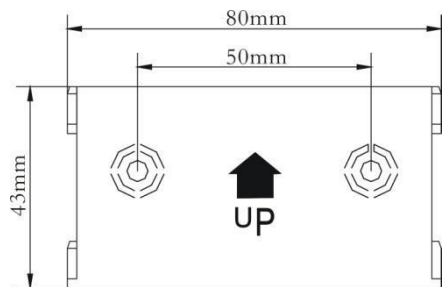

3.3 Preparation before wiring connection

Open/close the cover of connection terminal.

- ▶ Unscrew the screw ①②, and take out the cover upwards
- ▶ Close the cover: close the cover downwards
- ▶ Fix the cover with the screw ①②

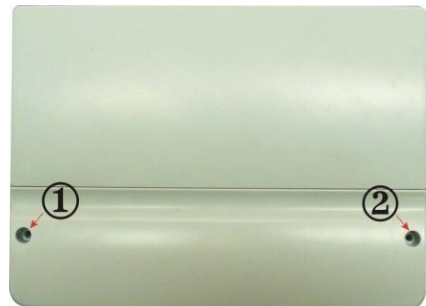

3.4 Wiring connection



Note: Power can only switched-on when the controller housing is closed. Installer should be sure that the IP safety protection grade of controller isn't damaged during installation.

According to the way of installation, wire can be connected from hole ④ on the bottom plate or from hole ⑤, using a suitable tool (like knife) to cut the plastic of ⑤, and wire is connected into housing from hole ⑤.



Note: wires must be fastened by fixing clamps on the position⑥.

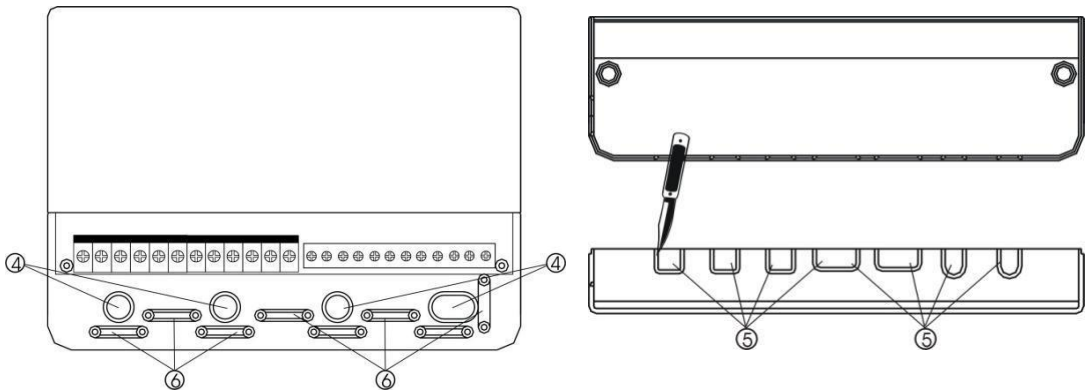

3.5 Terminal connection

 **Note:** before opening the housing! Always disconnect the controller from power supply and obey the local electrical supply regulation.

3.5.1 Terminal allocation of controller for electrical heater of 1500W

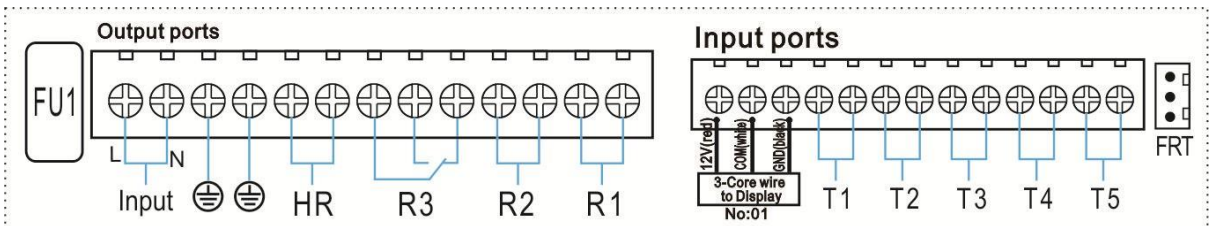

- **Input ports**

- T1: PT1000 temperature sensor, for measuring the temperature of collector
- T2 ~T5: NTC10K, B=3950 temperature sensor, for measuring temperature of tank and pipe.
- FRT: For rotary vane type electronic flowmeter

- **Display connection**

Port 1: connect red wire (+12V)

Port 2: connect white wire (COM)

Port 3: connect black wire (GND)

Note: please lead wire into indoors, and fix the cable outdoors.

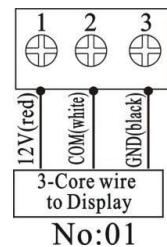

● **1500W Output ports**

- Input Ports L, N: for power connection, L: live wire, N: zero wire,  protective wire, with 10A power plug.
- Output R1: Electromagnetic relays, Max. Current: 2A
- Output R2: Electromagnetic relays, Max. Current: 2A
- Output R3: Electromagnetic relays, Max. Current: 2A
- **Output HR: Electromagnetic relays, designed for on/off control of back-up heating device, Max. Current: 10A (@AC230V, for □1500W electrical heater, @110VAC, for □750W electrical heater)**

3.3.2 Terminal allocation of controller for electrical heater of 3000W/4000W

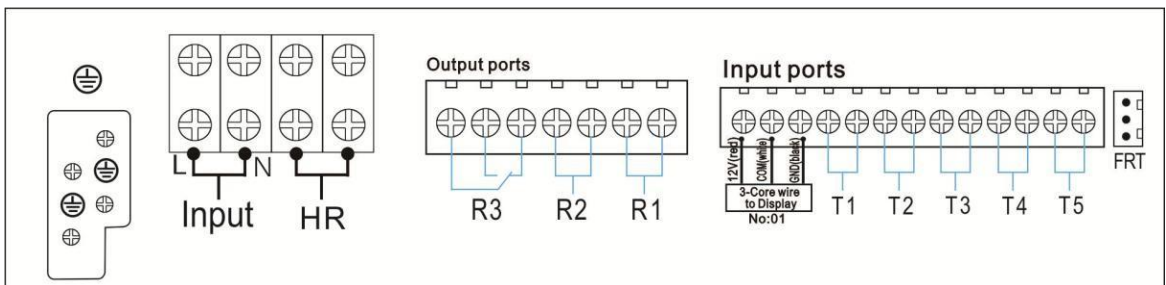

● **Input ports**

- T1: PT1000 temperature sensor, for measuring the temperature of collector
- T2 ~T5: NTC10K, B=3950 temperature sensor, for measuring temperature of tank and pipe.
- FRT: For rotary vane type electronic flowmeter

● **3000W/4000W Output ports**

- Input Ports L, N: for power connection, L: live wire, N: zero wire,  protective wire, it is better to use 2.5mm² cable.
- Output R1: Electromagnetic relays, for control pump or valve, Max. Current: 2A
- Output R2: Electromagnetic relays, for control pump or valve, Max. Current: 2A
- Output R3: Electromagnetic relays, for control pump or valve, Max. Current: 2A
- **3000W Output HR: Electromagnetic relays, designed for on/off control of back-up heating device, Max. Current: 15A (@AC230V, for □3000W electrical heater, @110VAC, for □1500W electrical heater)**
- **4000W Output HR: Electromagnetic relays, designed for on/off control of back-up heating device, Max. Current: 20A (@AC230V, for □4000W electrical heater,**

@110VAC, for □2000W electrical heater)

● **Advice regarding the installation of temperature sensors:**

- Only original factory equipped Pt1000 temperature sensors are approved for using with the controller, it is equipped with 1.5m silicon cable and suitable for all weather conditions, the cable is temperature resistant up to 280°C, connect the temperature sensors to the corresponding terminals with either polarity.
- Only original factory equipped NTC10K,B=3950 temperature sensors are approved for using with tank and pipe, it is equipped with 3m PVC cable, and the cable is temperature resistant up to 105°C, connect the temperature sensors to the corresponding terminals with either polarity.
- All sensor cables carry low voltage, and to avoid inductive effects, must not be laid close to 230 volt or 400 volt cables (minimum separation of 100mm).
- If external inductive effects are existed, e.g. from heavy current cables, overhead train cables, transformer substations, radio and television devices, amateur radio stations, microwave devices etc., then the cables to the sensors must be adequately shielded.
- Sensor cables may be extended to a maximum length of ca. 100 meter, when cable's length is up to 50m, and then 0.75mm² cable should be used. When cable's length is up to 100m, and then 1.5mm² cables should be used.

4. System description (Standard solar system with 1 tank, 1 collector field)

Description:

The controller calculates the temperature difference between collector sensor T1 and tank sensor T2. If the difference is larger than or identical to the adjusted switch-on temperature difference, the solar circulation pump (R1) will be switched on and the tank will be loaded until the switch-off temperature difference or the maximum tank temperature is reached.

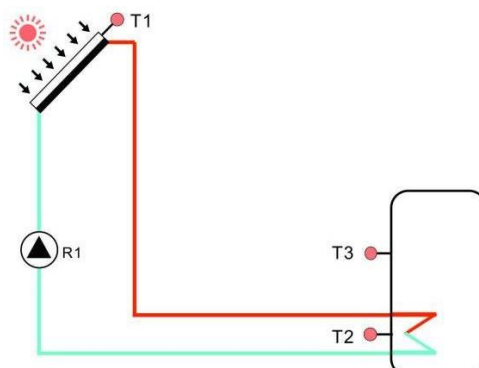

Sensor ports	Description	Relay outputs	Description
T1	Collector temperature sensor PT1000	R1	For solar circuit pump
T2	Temperature sensor on the bottom part of tank. NTC10K	R2	1. for DHW circuit function (CIRC) 2.OHDP (Thermal energy transferring, R2,R3 can be selected)
T3	Temperature sensor on the upper part of tank. NTC10K		
T4	Temperature sensor on DHW Pipe. NTC10K	R3	1. TIME (Timer function) 2.AH (Automatic thermostat function)
T5	Temperature sensor for thermostat function NTC10K	HR	For back-up heating

Note: when R3 output is selected for OHDP function, other two functions AH, TIME will be closed automatically. When one of these three functions (HEAT, OHDP, SFB) is activated, and then the other two will be deactivated automatically.

5. Time setup



Before switch-on the power, please connect sensor on the inputs terminal, connect pump or on/off valve on the outputs terminal. After the power is switched-on, you can set the time, password and parameters of system.

- ▶ Press "Clock" button, Time displays on the screen, hour "00" blinks on the display.
- ▶ Press "+/-" button, to adjust hour
- ▶ Press "Clock" button again, minute time "00" blinks on the display
- ▶ Press "+/-" button to adjust minute
- ▶ Press "ESC" button to save the set value



Note: In the case power to controller is switched-off, date and time will be memorized in controller for 36 hours.

6. Function's parameters and options

6.1 Overview of menu structure

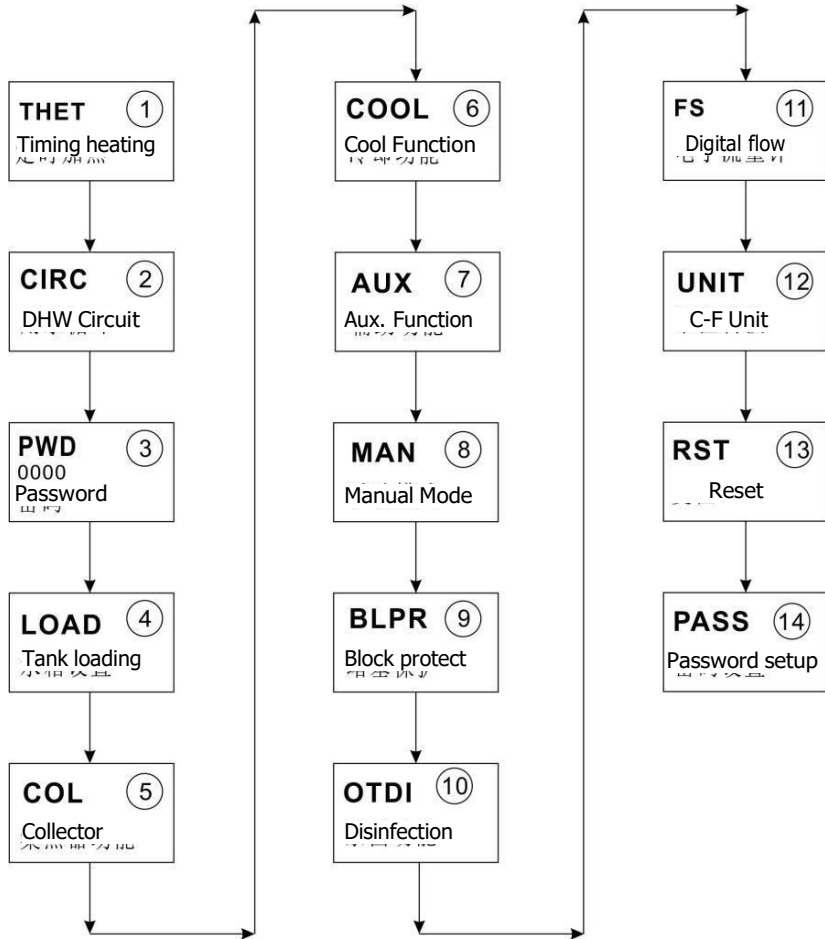

6.2 Menu operation description

- **Access main menu**

- ▶ Press "SET" button to access main menu
- ▶ Press "+/-" to select menu
- ▶ Press "SET" button to enter the submenu



- **Access submenu**

- ▶ After selecting main menu, then press "SET" button to access submenu

- ▶ Press “+/-” button to select submenu,
- ▶ Press “SET” button to enter the value adjust interface
- ▶ Press “+/-” to adjust value
- ▶ Press “SET” or “ESC” to confirm the value you set
- ▶ Press “ESC”, exit the submenu.

i **Note:** Enter the menu adjustment interface, if you don't press any button within 3 minutes, screen will exit the adjustment and turn to main interface.

6.3 Value checking and function checking

Under normal running status of controller, press “ +/-” button to check the measured value of temperature of collector and tank, value of flow rate (L/M) , status of thermal sterilization function , status of auxiliary functions , status of voltage of battery(VOL), running time of display (DAYS), running time of controller (MDAY), program version of display (SW), and program version of main controller (SW-M)



i **Note:**

- Flow rate, thermal sterilization function, auxiliary functions can only be displayed only when these functions are triggered.
- When thermal sterilization function is running, time of thermal sterilization can be checked. When one of any auxiliary functions is running, its corresponding signal blinks on the display.
- SW: program version of display, SW-M: program version of controller.
- DAYS:running time of display; MDAY:running time of controller
- When you already in the interface of value checking function, if no any button is pressed within 3 minutes, the display will return to the main interface.

7. Functions operation and parameters setting (for user)

7.1 Timing heating

Function description:

Electrical heater or gas / oil boiler is normally used as back-up heating source of a solar hot water system. Through this timing heating function controller can keep the tank temperature constantly. When tank temperature (T3) drops below the switch-on thermostats temperature, back-up heating output HR is triggered, when T3 rises up to the switch-off thermostats temperature, HR is ceased.

● Set time sections and temperature for timing heating

Factory set:

- ◇ The first time section: default at 4:00 to start heating, and at 5:00 to stop heating, and

- the switch-on temperature of heating is 40°C, switch-off temperature is 50°C。
- ◇ The second time section: default at 10:00 to start heating, and at 10:00 to stop heating,
 - ◇ The Third time section: default at 17:00 to start heating, and at 22:00 to stop heating, and the switch-on temperature of heating is 50°C, switch-off temperature is 55°C。

If you set the start time and close time with a same value, which means within this time section, the timing heating function is switched-off. For example, at the second time section, start time is set at 10:00, but close time is also set at 10:00.

Timing heating function is run at the preset time section, 3 time sections can be set, and within every time section, the desired temperature may be different. The adjustable range of switch-on temperature is 0°C ~ (OFF-2°C), switch-off temperature range is (ON+2°C) ~ 95°C.

● SMT Intelligent heating

At the case that solar energy is insufficient to heat the tank, in order to ensure user has sufficient hot water, controller will check the temperature of tank automatically at the preset time, if tank's temperature is not reached to the desired temperature, then back-up heat device will be triggered, and when tank's temperature rises up to the desired value, then back-up heat device stops.

Factory set: (impossible to be adjusted)

- ◇ Default at 13:00 of the first time section to trigger the back-up heat device to heat tank to 30 °C,
- ◇ Default at 14:00 of the second time section to trigger the back-up heat device to heat tank to 35 °C,
- ◇ Default at 15:00 of the third time section to trigger the back-up heat device to heat tank to 40 °C,
- ◇ Default at 16:00 of the forth time section to trigger the back-up heat device to heat tank to 45 °C,
- ◇ Default at 17:00 of the fifth time section to trigger the back-up heat device to heat tank to 50 °C.



Note:

1. If larger power electrical heater (larger than 1500KW) is used, according to the power, we suggest using controller with 3000W or 4000W output.

2. Please remark the power of electrical heater and the voltage used.

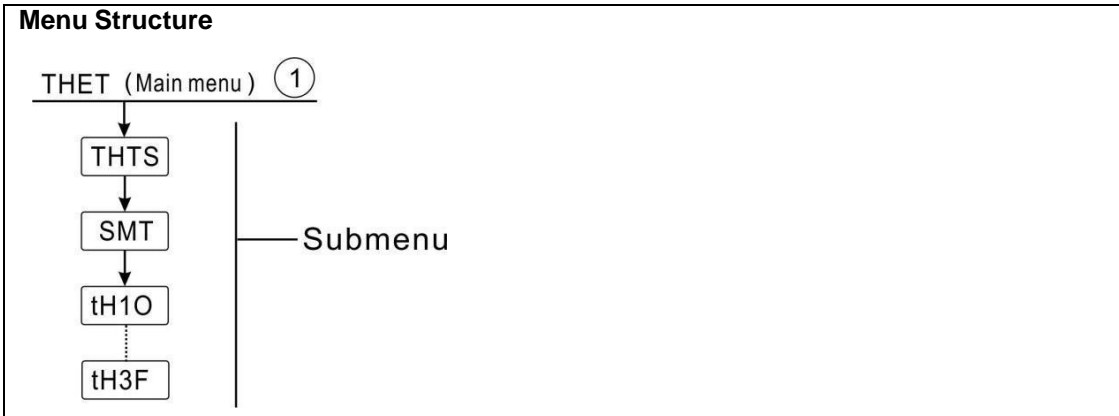

Main menu	Submenu	Factory set	Adjustable range	Step per adjust	Description
THET					Timing heating function
	THTS	S3	S2, S3		Select desired sensor of heated tank (S3 for T3, S2 for T2)
	SMT	OFF	ON/OFF		Intelligent heating Mode
	tH1O	04:00 / 40°C	00:00-23:59 / 0-93°C	0.5C	Switch-on time and temperature of the first heating section
	tH1F	05:00 / 50°C	00:00-23:59 / 2-95°C	0.5C	Switch-off time and temperature of the first heating section
	t H2O	10:00 / 40°C	00:00-23:59 / 0-93°C	0.5C	Switch-on time and temperature of the second heating section
	tH2F	10:00 / 50°C	00:00-23:59 / 2-95°C	0.5C	Switch-off time and temperature of the second heating section
	tH3O	17:00 / 50°C	00:00-23:59 / 0-93°C	0.5C	Switch-on time and temperature of the third heating section
	tH3F	22:00 / 55°C	00:00-23:59 / 2-95°C	0.5C	Switch-off time and temperature of the third heating section

Function setting:

- ▶ Press "SET" button to access main menu, and select THET timing heating menu.
- ▶ Press "SET" button to set parameter, firstly to select the desired sensor for the heated tank, "THTS S3" displays on the screen.



- ▶ Press "SET" button, "S3" blinks
- ▶ Press "+/-" button to select desired sensor
- ▶ Press "SET" or "ESC" button to save the setting.
- ▶ Press "+" button to access submenu of the intelligent heating, "SMT OFF" displays on the screen
- ▶ Press "SET" button, "OFF" blinks
- ▶ Press "+/-" button to activate this function
- ▶ Press "SET" or "ESC" button to save the setting.
- ▶ Press "SET" button to access the window of the switch-on time and temperature of the first heating section, "th1O 04: 00" displays on the screen.
- ▶ Press "SET" button, hour time "04" blinks
- ▶ Press "+/-" button to adjust hour of the switch-on time
- ▶ Press "SET" button, minute time "00" blinks
- ▶ Press "+/-" button to adjust minute of the switch-on time
- ▶ Press "SET" button, temperature "40" blinks
- ▶ Press "+/-" button to adjust the switch-on temperature
- ▶ Press "SET" or "ESC" button to save the setting.
- ▶ Press "+" button to access the window of the switch-off time and temperature of the first heating section, "th1F 05: 00" displays on the screen
- ▶ Press "SET" button, hour time "05" blinks
- ▶ Press "+/-" button to adjust hour of the switch-off time
- ▶ Press "SET" button, minute time "00" blinks
- ▶ Press "+/-" button to adjust minute of the switch-off time
- ▶ Press "SET" button, temperature "50" blinks
- ▶ Press "+/-" button to adjust the switch-off temperature
- ▶ Press "SET" or "ESC" button to save the setting.
- ▶ Press "+" button to access the window of the switch-on time and temperature of the second heating section, repeat above steps to set time and temperature for the second and third heating section.



Note: definition of timing heating sign

- 1) Within the preset time section, if timing heating isn't working, heating sign  is lighted on the screen

- 2) Within the preset time section, if timing heating is working, heating sign (☀️) blinks on the screen.
- 3) Out of the preset time section, heating sign (☀️) doesn't display on the screen.

7.2 CIRC DHW circulation pump controlled by temperature and time

Function description:

This controller provides an output for running DHW circulation pump, which can be controlled by a temperature sensor, at this case, an extra circuit pump (connect to the output R2) and an extra temperature sensor installed on the hot water return pipe (connect to the input T4) should be installed in the system. When the temperature of DHW return is lower than the preset switch-on temperature, circuit pump is triggered, until temperature rises up to the switch-off temperature, pump is stopped.

2 controlling modes are designed for running DHW circulation pump

- **Time controlled DHW pump within the preset 3 time sections (default Mode)**

Within a time section, if DHW circulation pump is controlled by time, at this case, only an extra circuit pump (connect to output R2) is needed. Pump is triggered by time, within a running time section, as default set, pump runs for 3 minutes (adjustable range 0-30 minutes) and then ceases for 15 minutes (adjustable range 0-60 minutes), same process repeated within the running time section.

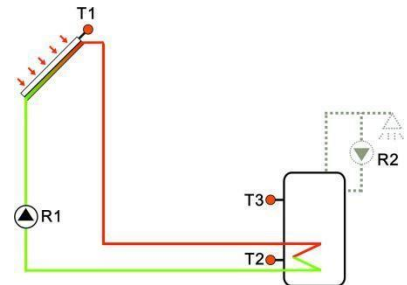

i Note: if the ceased time (CYCF) is set to 0 minute, it means within this time section, circuit pump keeps running without any stop.

Default time section:

- ✧ The first time section: starts at 05:00, stops at 7:00, runs 3 minutes, then stops 15 minutes
- ✧ The second time section: starts at 11:00, stops at 13:00, runs 3 minutes, then stops 15 minutes
- ✧ The first time section: starts at 17:00, stops at 22:00, runs 3 minutes, then stops 15 minutes

● **Temperature controlled DHW pump within the preset 3 time sections**

within a time section, when the DHW circulation pump is controlled by temperature, as default set, pump is triggered when return temperature T4 is below 40°C, and it is stopped when T4 rises up to 45°C,

There is a precondition for triggering the DHW circuit pump (set in submenu STAT):

START ON: tank's temperature sensor (default T3) is

2°C higher than the preset switch-off temperature, and then DHW circuit pump can be triggered.

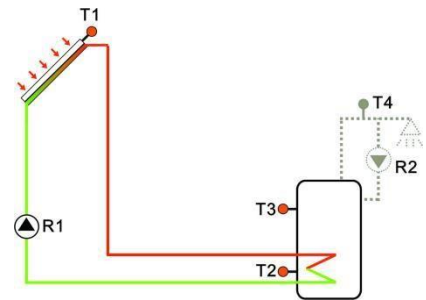

i **Note:** two Modes can't play at the same time, when time controlled Mode is selected, then temperature controlled Mode can't be activated.

Default time section:

- ◇ The first time section: starts at 05:00, stops at 7:00, runs at 40°C, stops at 45°C
- ◇ The second time section: starts at 11:00, stops at 13:00, runs at 40°C, stops at 45°C
- ◇ The first time section: starts at 17:00, stops at 22:00, runs at 40°C, stops at 45°C

If it is needed to close one time section, just set the start time and stop time at a same value (e.g. 10:00 starts, 10:00 stops)

i **Note:**

- 1) Only one control Mode can be selected, either time control mode or temperature control mode.
- 2) If sensor T4 should be installed, in order to avoid measuring error, please ensure to install sensor at 1.5m far to tank.
- 3) Both time control mode and temperature control mode, the parameter set steps are same.

Menu Structure

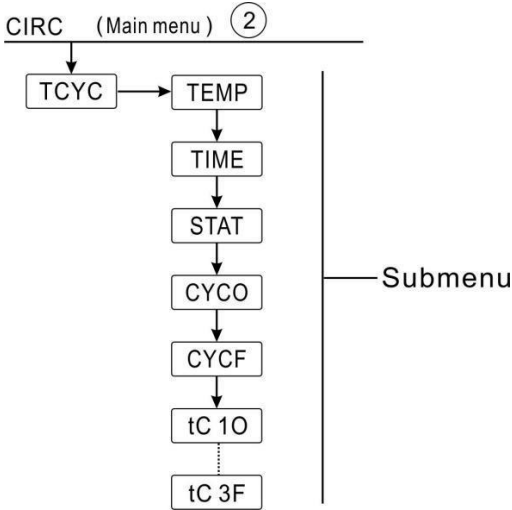

Main menu	Submenu 1	Submenu 2	Factory set	Adjustable range	Step per adjust	Description
CIRC						DHW circuit function
	TCYC		OFF	ON/OFF		Activate / deactivate the DHW circuit function
		TEMP	OFF			Temperature control DHW pump
		TIME	ON			Time control DHW pump
		STAT	ON	ON/OFF		Tank temperature (T3) 2°C higher than the preset switch-off DHW circuit temperature.
		CYCO	40 °C /3min	5-53°C/1-30min	0.5 °C /1min	Switch-on temperature or running time
		CYCF	45 °C /15min	7-55°C/0-60min	0.5 °C /1min	Switch-off temperature or stop time
		t C10	05:00	00:00-23:59		Switch-on time for the first time section
		t C1F	07:00	00:00-23:59		Switch-off time for the first time section

		t C2O	11:00	00:00-23:59		Switch-on time for the second time section
		t C2F	13:00	00:00-23:59		Switch-off time for the second time section
		t C3O	17:00 /	00:00-23:59 /		Switch-on time for the third time section
		t C3F	22:00	00:00-23:59		Switch-off time for the third time section

Function setup: (take temperature controlled DHW as example)

- ▶ Select main menu CIRC DHW circuit function
- ▶ Press "SET" button, "TCYC" displays on the screen.
- ▶ Press "SET" again, "TCYC OFF" displays on the screen
- ▶ Press "SET", "OFF" blinks
- ▶ Press "+/-" button to activate this function
- ▶ Press "SET" or "ESC" button to save the setting



- ▶ Press "+" button, "TEMP OFF" displays on the screen (temperature control Mode)
- ▶ Press "SET", "OFF" blinks
- ▶ Press "+/-" button to activate this function
- ▶ Press "SET" or "ESC" button to save the setting.

- ▶ Press "+" button, "TIME ON" displays on the screen (time control Mode, default as on)
- ▶ Press "SET", "ON" blinks
- ▶ Press "+/-" button to deactivate this function
- ▶ Press "SET" or "ESC" button to save the setting.

- ▶ Press "+" button, "STAT ON" displays on the screen (Switch-on condition under temperature control Mode, under time control Mode, no this function)

- ▶ Press "SET", "ON" blinks (default as open)
- ▶ Press "+/-" button to deactivate this function
- ▶ Press "SET" or "ESC" button to save the setting.

- ▶ Press "+" button, "CYCO 40°C" displays on the screen, set the switch-on temperature of DHW circuit (if select time control Mode, then "CYCO 03Min" displays, here take temperature

as example)

- ▶ Press "SET", "40°C" blinks
- ▶ Press "+/-" button to adjust the switch-on temperature (adjustable range 0°C ~ (OFF-2°C))
- ▶ Press "SET" or "ESC" button to save the setting.

- ▶ Press "+" button, "CYCF 45°C" displays on the screen, set the switch-off temperature of DHW circuit
- ▶ Press "SET", "45°C" blinks
- ▶ Press "+/-" button to adjust the switch-off temperature (adjustable range ON+2°C ~ 55°C)
- ▶ Press "SET" or "ESC" button to save the setting.

- ▶ Press "+" to access 3 time sections setting, "tC1O 05:00" displays on the screen, set the start time of the first time section.
- ▶ Press "SET", time hour "05" blinks,
- ▶ Press "+/-" to adjust hour of the circuit start time.
- ▶ Press "SET", time minute "00" blinks,
- ▶ Press "+/-" to adjust minute of the circuit start time.
- ▶ Press "SET" or "ESC" button to save the setting.

- ▶ Press "+" to access the stop time of the first time section, "tC1F 07:00" displays on the screen,
- ▶ Press "SET", time hour "07" blinks,
- ▶ Press "+/-" to adjust hour of the circuit stop time.
- ▶ Press "SET", time minute "00" blinks,
- ▶ Press "+/-" to adjust minute of the circuit stop time.
- ▶ Press "SET" or "ESC" button to save the setting.

- ▶ Press "+" to access the start time of the second time section, repeat above step to set start and stop time for second and third time section.

If you want to close the DHW circuit within one time section, and then just set its start time and close time with a same value, for example, at the second time section, start time is set at 10:00, but close time is also set at 10:00.

8. Function operation and parameter setup (engineer)

8.1 PWD Password

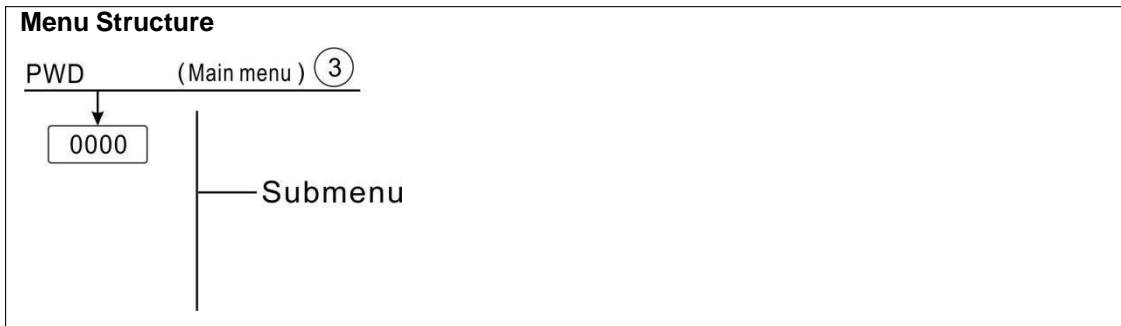

Access main menu, select "PWD 0000" to enter password

- ▶ Press "SET" button, the left digital blinks, enter password, factory set is "0000"
- ▶ Press "+/-", to enter the first digital
- ▶ Press "SET", the second digital blinks
- ▶ Press "+/-" to enter the second digital
- ▶ Press "SET", the third digital blinks
- ▶ Press "+/-" to enter the third digital
- ▶ Press "SET", the fourth digital blinks
- ▶ Press "+/-" to enter the fourth digital
- ▶ Press "SET", to access main menu



Through password set to limit the user to change some parameters, 4 digitals needed.
Default is 0000

If no password is set, then just press "SET" five times to access main menu directly.

8.2 LOAD tank heating

Function description:

- **ΔT control logic**

The controller works as a standard temperature differential controller. If the temperature reaches or exceeds the switch-on temperature difference (DTO), the pump R1 switches on. When the temperature difference reaches or falls below the adjusted switch-off temperature difference (DTF), the respective relay R1 switches off.



Note: The switch-on temperature difference must be 0.5 K higher than the switch-off

temperature difference. The set temperature difference must be at least 0.5 K higher than the switch-on temperature difference.

● **SMX Maximum tank temperature protection set**

If the tank temperature reaches the adjusted maximum temperature, the tank will no longer be loaded in order to avoid damage caused by overheating. If the maximum tank temperature is exceeded, sign ☀ is displayed on the screen.

The sensor for tank maximum limitation (SMAX) can be selected. The maximum limitation always refers to the sensor selected (T2 or T3). The switch-on hysteresis (HYST) is selectable(Default is 2°C), for example, when tank maximum temperature is set to 70°C, then at 68 °C, Maximum tank temperature protection function is deactivated automatically.

Menu Structure					
LOAD (Main menu) ④					
<pre> graph TD LOAD --> DTO DTO --> DTF DTF --> SMX SMX --> SMA SMA --> HYST </pre>					
				Submenu	
Main menu	Sub menu	Factory set	Adjustable range	Step per adjust	Description
LOAD					Tank heating
	DTO	6K	1-50K	0.5K	Switch-on temperature difference of tank heating
	DTF	4K	0.5-49.5K	0.5K	Switch-off temperature difference of tank heating
	SMX	70°C	4-95°C	1°C	Maximum temperature of tank
	SMA X	S3	S2, S3		Sensor for Maximum temperature of tank (S3 for T2, S2 for T2)
	HYST	2K	0.1-10K	0.1K	Hysteresis of maximum temperature of tank

Setup the function

- ▶ Select "LOAD" main menu
- ▶ Press "SET", "DTO 6K" displays on the screen





- ▶ Press "SET", "6K" blinks
- ▶ Press "+/-", to adjust the switch-on temperature of the solar circuit pump
- ▶ Press "SET" or "ESC" to save the setting
- ▶ Press "+", "DTF 4K" displays on the screen
- ▶ Press "SET", "4K" blinks
- ▶ Press "+/-", to adjust the switch-off temperature of solar circuit pump
- ▶ Press "SET" or "ESC" to save the setting

- ▶ Press "+", "SMX 70°C" displays on the screen
- ▶ Press "SET", "70°C" blinks
- ▶ Press "+/-", to adjust the maximum temperature of tank
- ▶ Press "SET" or "ESC" to save the setting
- ▶ Press "+", "SMAX S3" displays on the screen
- ▶ Press "SET", "S3" blinks
- ▶ Press "+/-", select the sensor for maximum temperature of tank (S3 for T3, S2 for T2)
- ▶ Press "SET" or "ESC" to save the setting
- ▶ Press "+", "HYST 2K" displays on the screen
- ▶ Press "SET", "2K" blinks
- ▶ Press "+/-", to adjust the hysteresis of tank maximum temperature
- ▶ Press "SET" or "ESC" to save the setting

8.3 COL Collector function

Function description

- **OCEM Collector emergency shutdown**

When the collector temperature exceeds the adjusted collector emergency temperature, Then solar pump (R1) switches off in order to protect the system components against overheating (collector emergency shutdown). If the maximum collector temperature (OCEM) is exceeded, sign   blinks on the screen.

 **Warning!** Risk of injury! Risk of system damage by pressure surge! If water is used as the heat transfer fluid in pressure systems, water will boil at 100 °C. Then do not set the collector limit temperature higher than 95 °C.

- **OCCO Collector cooling**

The collector cooling function keeps the collector temperature rising within the operating range by heating the tank. If the tank temperature reaches 95°C the function will be switched off for safety reasons.

When the tank temperature exceeds the adjusted maximum temperature of tank, then solar system is switched off. If the collector temperature rises up to its adjusted maximum collector temperature, the solar pump is switched on again until the collector temperature falls below the maximum collector temperature. The tank temperature may then exceed its maximum temperature, but only up to 95°C (emergency shutdown of the tank), and sign  blinks on the screen, system stops.

If the collector cooling is active,  blinks on the screen.

 **Note:** This function is only available when the heat transfer function (OHDP) is not activated.

- **OCMI Collector minimum temperature**

The minimum collector temperature is the lowest temperature of collector, only when collector temperature is higher than that temperature, solar pump (R1) just can be switched-on, if the collector temperature falls below the adjusted minimum temperature, Sign  blinks on the screen (slowly blinks).

- **OCFR Collector antifreeze function**

Collector antifreeze function activates the loading circuit between the collector and the tank when the collector temperature falls below the adjusted temperature **CFRO**. This will protect the fluid against freezing or coagulating. If collector temperature exceeds the switch-off temperature of collector antifreeze function CFRF, the solar pump will be switched off again.

If collector antifreeze function is activated, sign  blinks on the screen.

 **Note:** Since this function uses the limited heat which is saved in the tank, so the antifreeze function should be used only in regions where the ambient temperature is around the freezing point only for a few days.

Menu structure						
COL (Main menu) ⑤						
<pre> graph TD COL[COL (Main menu) ⑤] --> OCEM[OCEM] COL --> OCCO[OCCO] COL --> OCMI[OCMI] COL --> OCFR[OCFR] OCEM --> CEM[CEM] OCCO --> CMAX[CMAX] OCMI --> CMIN[CMIN] OCFR --> CFRO[CFRO] CFRO --> CFRF[CFRF] </pre>						
Main menu	Submenu 1	Submenu 2	Factory set	Adjustable range	Step per adjust	Description
COL						Collector function
	OCEM		ON			Collector emergency shutdown function on/ff
		CEM	130℃	80-200℃	1℃	Temperature of collector emergency shutdown(hysteresis 10K)
	OCCO		OFF			Collector cooling function on/off
		CMAX	110℃	70-160℃	1℃	Temperature of collector cooling (hysteresis 5℃)
	OCMI		OFF			Collector minimum temperature function on/off
		CMIN	10℃	10-90℃	1℃	Temperature of collector minimum function
	OCFR		OFF			Anti-freeze function on/off
		CFRO	4℃	-40-8℃	0.5℃	Switch-on temperature of anti-freeze function
		CFRF	5℃	-39-9℃	0.5℃	Switch-off temperature of anti-freeze function

Function setting:

OCEM (Collector emergency shutdown function) setup

- ▶ Select "COL" function menu
- ▶ Press "SET", "OCEM" displays on the screen
- ▶ Press "SET" again, "OCEM ON" displays on the screen
- ▶ Press "SET", "ON" blinks on the screen



(If it is necessary to shut down this function, press "+/-" to deactivate it)

- ▶ Press "SET" or "ESC" to save the setting
- ▶ Press "+", "OCEM 130°C" displays on the screen
- ▶ Press "SET", "130°C" blinks on the screen
- ▶ Press "+/-", to adjust the temperature of the collector emergency function
- ▶ Press "SET" or "ESC" to save the setting
- ▶ Press "ESC" to return to previous menu

OCCO (Collector cooling function) setup

- ▶ Select OCCO submenu, "OCCO" displays on the screen
- ▶ Press "SET", "OCEM OFF" displays on the screen
- ▶ Press "SET", "OFF" blinks on the screen
- ▶ Press "+/-", to activated this function, "OCEM ON" displays on the screen
- ▶ Press "+", "CMAX 110°C" displays on the screen
- ▶ Press "+/-", to adjust the switch-on temperature of collector cooling function
- ▶ Press "SET" or "ESC" to save the setting
- ▶ Press "ESC" to return to previous menu

OCMI (Collector minimum temperature) setup

- ▶ Select OCMI submenu, "OCMI" displays on the screen
- ▶ Press "SET", "OCMI OFF" displays on the screen
- ▶ Press "SET", "OFF" blinks on the screen
- ▶ Press "+/-", to activate this function, "OCMI ON" displays on the screen
- ▶ Press "+", "OCMI 10°C" displays on the screen
- ▶ Press "+/-", to adjust the minimum temperature of collector
- ▶ Press "SET" or "ESC" to save the setting
- ▶ Press "ESC" to return to previous menu

OCFR (Antifreeze function) setup

- ▶ Select OCFR submenu, "OCFR" displays on the screen
- ▶ Press "SET", "OCFR OFF" displays on the screen
- ▶ Press "SET", "OFF" blinks on the screen
- ▶ Press "+/-", to activate this function, "OCFR ON" displays on the screen
- ▶ Press "+", "CFRO 4°C" displays on the screen
- ▶ Press "SET", "4°C" blinks on the screen
- ▶ Press "+/-", to adjust the switch-on temperature of antifreeze function
- ▶ Press "SET" or "ESC" to save the setting
- ▶ Press "+", "CFRF 5°C" displays on the screen
- ▶ Press "SET", "5°C" blinks on the screen
- ▶ Press "+/-", to adjust the switch-off temperature of antifreeze function
- ▶ Press "SET" or "ESC" to save the setting
- ▶ Press "ESC" to return to previous menu

8.4 COOL Cooling function

Function description

2 cooling functions for different devices can be activated by this function: tank cooling, heat transferring by external radiator

● **OSTC Tank cooling**

When the tank cooling function is activated, the controller aims to cool down the tank during the night in order to prepare it for solar loading on the following day. If the tank temperature exceeds the adjusted maximum tank temperature SMAX, the collector temperature falls below the tank temperature and downwards to the switch-on temperature difference DTCO of this cooling function, then system will be activated in order to cool down the tank by releasing the energy through the collector.

If tank cooling function is activated, sign  blinks on the screen



Note: if tank temperature reaches to 95 °C, all cooling functions will be locked. Hysteresis switch on temperature difference is 5K.

● **OHDP Heat transferring by external radiator**

Heat transferring by external radiator function is designed to transfer the excess heat which is generated under the strong solar irradiation through an external heat exchanger (e. g. fan

coil); the purpose is to keep the collector's or tank's temperature within the operating range. For this function, an extra output should be added (R2 or R3 as option)
 Heat transferring by external radiator function can control either an additional pump or a valve (**OTPM ON** = pump logic, **OTPM OFF** = valve logic).

Heat transferring by external pump:

If the collector temperature reaches the adjusted switch-on temperature, the allocated relay for pump is energized with 100 %; if the collector temperature falls by 5 K below the adjusted collector overheat-temperature, the relay will be switched off. When heat transferring is achieved by pump, then the heat transferring function is independent from solar loading.

Below is the example of this application for reference.

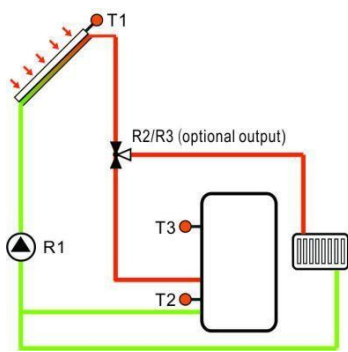

Collector valve logic heat transferring

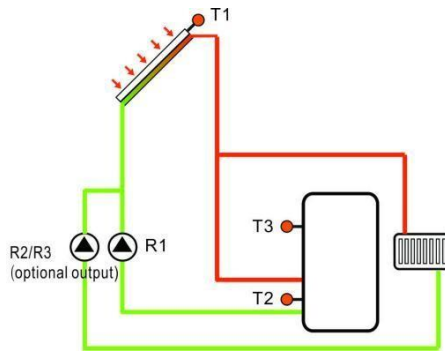

Collector pump logic heat transferring

Sign  displays on the screen, it indicates that valve logic heat transferring is running.

Sign  displays on the screen, it indicates that pump logic heat transferring is running.

i Note:

1. When collector overheat temperature OTST is 10K below the CEM temperature of collector emergency shutdown, then collector overheat temperature OTST is locked
2. Heat transferring function is only available when collector cooling function (OCCO) is deactivated.

Menu structure						
Main menu	Submenu 1	Submenu 2	Factory set	Adjustable range	Step per adjust	Description
COOL						Cooling function
	OSTC		OFF	ON/OFF		Tank cooling function
		DTCO	20K	1-30K	0.5K	Switch-on temperature difference of cooling function
		DTCF	15K	0.5-29.5K	0.5K	Switch-off temperature difference of cooling function
	OHDP		OFF	ON/OFF		Heat transferring by external radiator (only in case there is available output)
		OTST	80°C	20-160°C	1°C	Temperature set point for heat transferring (hysteresis 5°C)
		OTPM	ON	OTPM ON=pump Logic OTPM OFF=Valve logic		Pump control logic and valve control logic
		REL	R3	R3,R2		Output ports

Function setting:

OSTC (Tank cooling) setup

- ▶ Select "OSTC" function submenu, "OSTC" displays on the screen
- ▶ Press "SET", "OSTC OFF" displays on the screen



- ▶ Press "SET", "OFF" blinks on the screen
- ▶ Press "+/-", to activate this function
- ▶ Press "+", "DTCO 20K" displays on the screen
- ▶ Press "SET", "20K" blinks on the screen
- ▶ Press "+/-", to adjust the switch-on temperature difference of tank cooling function
- ▶ Press "SET" or "ESC" to save the setting
- ▶ Press "+", "DTCF 15K" displays on the screen
- ▶ Press "SET", "15K" blinks on the screen
- ▶ Press "+/-", to adjust the switch-off temperature difference of tank cooling function
- ▶ Press "SET" or "ESC" to save the setting
- ▶ Press "ESC" to return to previous menu

OHDP (Heat transferring) setup

- ▶ Select "OHDP" function sub-menu, "OHDP" displays on the screen
- ▶ Press "SET", "OHDP OFF" displays on the screen
- ▶ Press "SET", "OFF" blinks on the screen
- ▶ Press "+/-", to activate this function, "OHDP ON" displays on the screen
- ▶ Press "+", "OTST 80°C" displays on the screen
- ▶ Press "SET", "80°C" blinks on the screen
- ▶ Press "+/-", to adjust the switch-on temperature of heat transferring function
- ▶ Press "SET" or "ESC" to save the setting
- ▶ Press "+", "OTPM ON" displays on the screen
- ▶ Press "SET", "ON" blinks on the screen
- ▶ Press "+/-", to select pump logic or valve logic for heat transferring function
- ▶ Press "SET" or "ESC" to save the setting
- ▶ Press "+", "REL 3" displays on the screen
- ▶ Press "SET", "3" blinks on the screen
- ▶ Press "+/-", to select the output port for heat transferring function
- ▶ Press "SET" or "ESC" to save the setting
- ▶ Press "ESC" to return to previous menu

8.5 AUX Auxiliary function

Function description:

- **TIME Timer function**

Timer function can trigger controller's output port at the preset time; therefore, an available output (R3) is needed.

- **AH Thermostat function**

The thermostat function works independently from the solar operation and can be used for using surplus energy to reduce tank temperature or for using after heating to rise tank temperature. (Every day 3 heating time sections can be set),

i **Note:**

- **AH O < AH F:** Thermostat function is used for after heating
- **AH O > AH F:** Thermostat function is used for releasing surplus energy from tank.
 - ◇ When sign **AH** displays on the screen, it indicates that thermostat function is activated.
 - ◇ When sign **AH** blinks on the screen (blinks quickly) , it indicates that thermostat function (heating) is running.
 - ◇ When sign **AH** blinks on the screen (blinks slowly) , it indicates that thermostat function (heat releasing) is running.

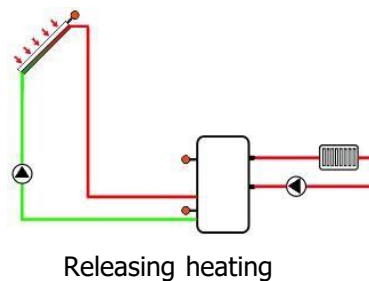
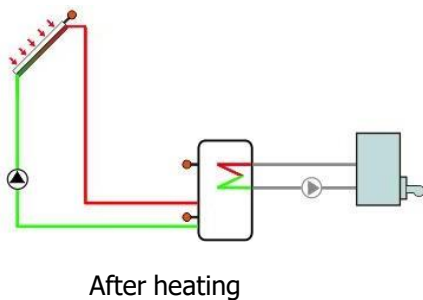

- **BEEP Beeper fault warning**

When system has fault (temperature sensor fault, no flow etc), beeper sends out warning

Menu Structure

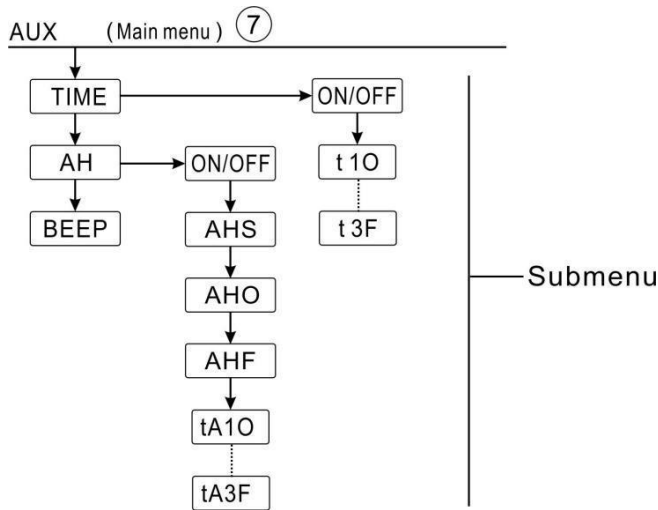

Main menu	Submenu 1	Submenu 2	Factory set	Adjustable range	Step per adjust	Description
AUX						Auxiliary functions
	TIME		OFF	ON/OFF		Timer function
		t 10	00:00	00:00-23:59		Start time of the first time section
		t 1F	00:00	00:00-23:59		Close time of the first time section
		t 20	00:00	00:00-23:59		Start time of the second time section
		t 2F	00:00	00:00-23:59		Close time of the second time section
		t 30	00:00	00:00-23:59		Start time of the third time section
		t 3F	00:00	00:00-23:59		Close time of the third time section
	AH		OFF	ON/OFF		Thermostat function
		AHS	S3	S2/S3/S5		Allocated sensor for thermostat function (S3 for T3, S2 for T2, S4 for T4)

		AHO	40°C	0.0-95°C	0.5°C	Switch-on temperature
		AHF	45°C	0.0-94.5 °C	0.5°C	Switch-off temperature
		t A1O	00:00	00:00-23: 59		Start time of the first time section
		t A1F	23:59	00:00-23: 59		Close time of the first time section
		t A2O	00:00	00:00-23: 59		Start time of the second time section
		t A2F	00:00	00:00-23: 59		Close time of the second time section
		t A3O	00:00	00:00-23: 59		Start time of the third time section
		t A3F	00:00	00:00-23: 59		Close time of the third time section
	BEEP		OFF	ON/OFF		Beeper warning function (sensor fault, no flow)

Function Setting

● TIME (Timer function) Setting

- ▶ Select AUX main menu, press "SET", to access TIME submenu
- ▶ Press "SET", "TIME OFF" displays on the screen
- ▶ Press "SET", "OFF" blinks
- ▶ Press "+/-", to activate this function, "TIME ON" displays
- ▶ Press "SET" or "ESC" to save the setting
- ▶ Press "+", "t1O 00:00" displays on the screen
- ▶ Press "SET", hour "00" blinks
- ▶ Press "+/-", to adjust hour of the start time of the first section
- ▶ Press "SET", minute "00" blinks
- ▶ Press "+/-", to adjust minute of the start time of the first section
- ▶ Press "SET" or "ESC" to save the setting
- ▶ Press "+", "t1F 00:00" displays on the screen
- ▶ Press "SET", hour "00" blinks
- ▶ Press "+/-", to adjust the hour of the close time of the first time section



- ▶ Press "SET", minute "00" blinks
- ▶ Press "+/-" to adjust the minute of the close time of the first time section
- ▶ Press "SET" or "ESC" to save the setting
- ▶ Press "+", access the setting of the second time section, repeat above steps to set time of second and third sections.

If you want to close the timer for one section, just set a same time for the start and close time (e.g. 10:00 start, 10:00 close)

● **AH (Thermostats function) setting**

- ▶ Select AH submenu, "AH" displays on the screen
- ▶ Press "SET", "AH OFF" displays
- ▶ Press "SET", "OFF" blinks
- ▶ Press "+/-", to activate this function, "AH ON" displays on the screen
- ▶ Press "SET" or "ESC" to save the setting
- ▶ Press "+", "AHS S3" displays on the screen
- ▶ Press "SET", "S3" blinks
- ▶ Press "+/-", to select the object sensor for thermostat function
- ▶ Press "SET" or "ESC" to save the setting
- ▶ Press "+", "AHO 40°C" displays
- ▶ Press "SET", "40°C" blinks
- ▶ Press "+/-", to adjust the switch-on temperature
- ▶ Press "SET" or "ESC" to save the setting
- ▶ Press "+", "AHF 45°C" displays
- ▶ Press "SET", "45°C" blinks
- ▶ Press "+/-", to adjust the switch-off temperature of thermostat function
- ▶ Press "SET" or "ESC" to save the setting
- ▶ Press "+", "tA1O 00:00" displays
- ▶ Press "SET", hour "00" blinks
- ▶ Press "+/-", to adjust the hour of start time of the first time section
- ▶ Press "SET", minute "00" blinks
- ▶ Press "+/-", to adjust the minute of start time of the first time section
- ▶ Press "SET" or "ESC" to save the setting

- ▶ Press "+", "tA1F 23:59" displays on the screen

- ▶ Press "SET", "23" blinks
- ▶ Press "+/-", to adjust the hour of close time of the first time section
- ▶ Press "SET", "59" blinks
- ▶ Press "+/-", to adjust the minute of close time of the first time section
- ▶ Press "SET" or "ESC" to save the setting
- ▶ Press "+", access the setting of the second time section, repeat above steps to set time of second and third sections.

If you want to close the thermostat function for one section, just set a same time for the start and close time (e.g. 10:00 start, 10:00 close)

● **BEEP (Beeper warning function) setting**

- ▶ Select BEEP submenu, "BEEP" displays on the screen
- ▶ Press "SET", "BEEP OFF" displays on the screen
- ▶ Press "SET", "OFF" blinks
- ▶ Press "+/-", to activate this function, "BEEP ON" displays on the screen
- ▶ Press "SET" or "ESC" to save the setting

8.6 MAN Manual operation

For control and service work, the operating mode of the relays can be manually adjusted. For this purpose, select the adjustment menu MAN (for R1, R2, R3, HR) to set output "On/OFF" Manually.

i **Note:** When manual mode is activated, sign (ⓘ) blinks on the screen, controller runs for 15 minutes and then switch-off all outputs, control exits manual mode automatically.

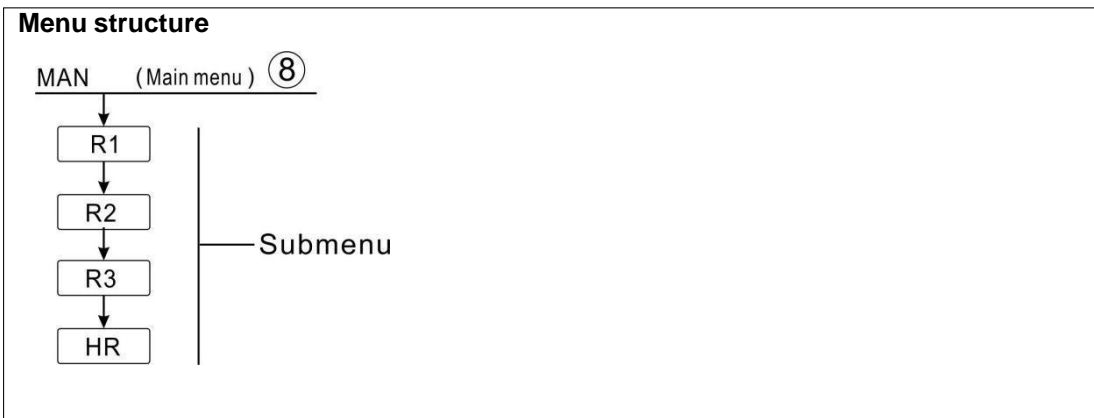

Main Menu	Sub menu	Factory set	Adjustable range	Description
MAN				Manual mode
	R1	OFF	ON/OFF	R1 on and off
	R2	OFF	ON/OFF	R2 on and off
	R3	OFF	ON/OFF	R3 on and off
	HR	OFF	ON/OFF	HR on and off

Function setup

- ▶ Select "MAN" main menu.
- ▶ Press "SET", "R1 OFF" displays
- ▶ Press "SET", "OFF" blinks
- ▶ Press "+/-", to activate this function, "R1 ON" displays
- ▶ Press "SET" or "ESC" to save the setting
- ▶ Press "+", "R2" displays, repeat above steps to set the manual output of R2, R3, HR.



i Note: when a output is triggered manually, only this output is triggered, others running output will be stopped.

8.7 BLPR Blocking protection

Function description:

In order to protect the pumps against blocking after standstill, the controller is equipped with a blocking protection function. This function switches on the relays one after another every day at 12:00 a.m and let them run for 10s.



Function setting

- ▶ Select BLPR main menu,
- ▶ Press "SET", "BLPR OFF" displays
- ▶ Press "SET", "OFF" blinks



- ▶ Press "+/-", to activate this function, "BLPR ON" displays on the screen
- ▶ Press "SET" or "ESC" to save the setting

8.8 OTDI Thermal Sterilization Function

Function description:

This function helps to prevent the spread of Legionella in DHW tanks by systematically activating the after-heating.

For thermal disinfection, the temperature at the allocated sensor has to be monitored. During the monitoring period PDIS, this protection ensures the disinfection temperature is continuously exceeded the disinfection temperature TDIS for the entire disinfection period DDIS. Thermal disinfection can only be completed when the disinfection temperature is exceeded for the duration of the disinfection period without any interruption.

The monitoring period PDIS starts as soon as the temperature at the allocated sensor falls below the disinfection temperature TDIS, once the monitoring period PDIS ends, disinfection period SDIS starts, and the allocated reference relay activates the after-heating, when tank temperature exceeds the disinfection temperature, disinfection phase DDIS starts and disinfection heating time countdowns, countdown finishes, disinfection heating finishes.

Menu Structure

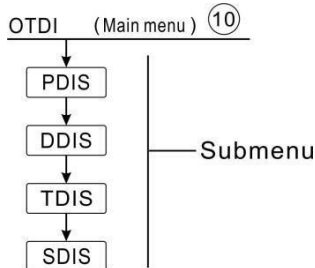

Menu	Submenu	Factor y set	Adjustable range	Step per adjust	Description
OTDI		OFF	ON/OFF		Disinfection function
	PDIS	7d	0-30d	1d	Time section of disinfection monitoring
	DDIS	10min	1-180	1min	Heating time of disinfection
	TDIS	70°C	0-90°C	1°C	Temperature of disinfection
	SDIS	18:00	00:00-21:00	1:00	Start time of disinfection

Function setting

- ▶ Select OTDI main menu
- ▶ Press "SET", "OTDI OFF" display
- ▶ Press "SET", "OFF" blinks
- ▶ Press "+/-", to activate this function, "OTDI ON" displays
- ▶ Press "SET" or "ESC" to save the setting
- ▶ Press "+", "PDIS 7" displays
- ▶ Press "SET", "7" blinks
- ▶ Press "+/-", to adjust the days for disinfection monitoring,
- ▶ Press "SET" or "ESC" to save the setting



- ▶ Press "+", "DDIS 10Min" displays on the screen
- ▶ Press "SET", "10" blinks
- ▶ Press "+/-", to adjust the heating time of disinfection
- ▶ Press "SET" or "ESC" to save the setting
- ▶ Press "+", "TDIS 70°C" displays on the screen
- ▶ Press "SET", "70°C" blinks
- ▶ Press "+/-", to adjust the temperature of disinfection
- ▶ Press "SET" or "ESC" to save the setting
- ▶ Press "+", "SDIS 18:00" displays on the screen
- ▶ Press "SET", "18" blinks
- ▶ Press "+/-", to adjust the start time of the disinfection
- ▶ Press "SET" or "ESC" to save the setting



8.9 FS Flow rate monitoring and pump dry-running protection

Function Description:

In order to achieve flow rate monitoring, an extra digital flow counter FRT (see accessories) is needed, and it is installed on the solar return pipe, when solar pump R1 runs, the flow rate in the system is monitored, and it keeps the system runs properly.

If relay R1 is powered, flow rate of flow sensor will be monitored. After 30 seconds, if no flow rate is detected, then solar pump R1 is ceased, and error message will appear, and at the same time sign   blinks on the screen. It can avoid damaging system, for example, avoiding pump dry running. Under the main display screen, press "+/-", you can view the flow rate value. When error appears, press "+/-" to check the flow rate value, you can press "SET"

button for 3 seconds to switch-off FS function, and after the fault is removed, then monitoring function is activated again.

Flow monitoring function is designed to detect whether flow exists in the solar system and therefore to switch-off the corresponding pump in case of no flow,

If "OFF" option of the flow monitoring function is activated, and then the loaded tank is stopped to be heated until error message is removed, then monitoring function is activated again.

i **Note:** reasons of no flow in the solar system:

- No flow due to pipe leakage in system
- Circuit pump is damaged.
- Digital flow counter is blocked or damaged.

Under this menu, it is possible to activate or deactivate the flow monitoring function.

If flow monitoring function is activated, flow sign  displays on the screen, and under the checking status, current flow can be checked L/M

i **Note:** digital flow counter FRT is not listed in the standard delivery, user should buy it separately (see item 12 Accessories).

Menu Structure					
<div style="border: 1px solid black; padding: 5px;"> <p>FS (Main menu) ⑪</p> <p>↓</p> <p>ON/OFF</p> <p>— Submenu</p> </div>					
Main menu	Sub menu	Factory set	Adjustable range	Step per adjust	Description
FS	OFF	OFF	OFF / ON		Flow monitoring function

Function setting

- ▶ Select FS main menu
- ▶ Press "SET", "FS OFF" displays



- ▶ Press "SET", "OFF" blinks
- ▶ Press "+/-", to activate this function, "FS ON" displays
- ▶ Press "SET" or "ESC" to save the setting

8.10 UNIT C-F Switch

Under this menu, below unit can be set:

Unit of temperature can be switched between Celsius and Fahrenheit

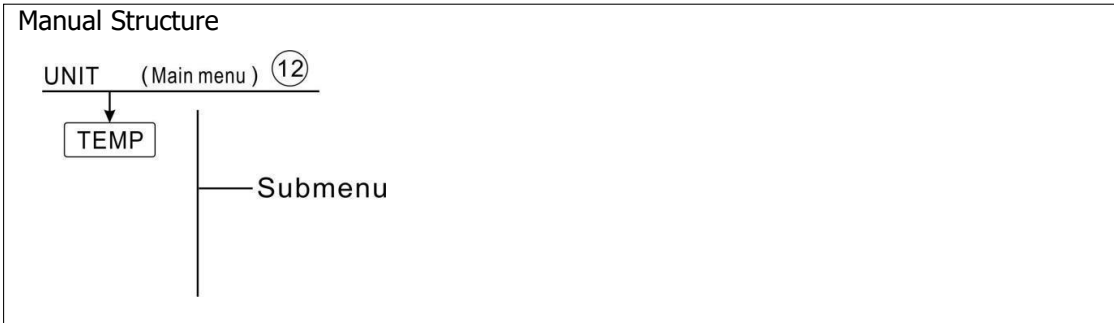

Function setting

- ▶ Select UNIT menu
- ▶ Press "SET", "TEMP °C" displays on the screen
- ▶ Press "SET", "°C" blinks
- ▶ Press "+/-", to select temperature unit
- ▶ Press "SET" or "ESC" to save the setting



8.11 RET Reset

RSTP (Menu parameters): through reset function, all parameters can be reset to factory setting

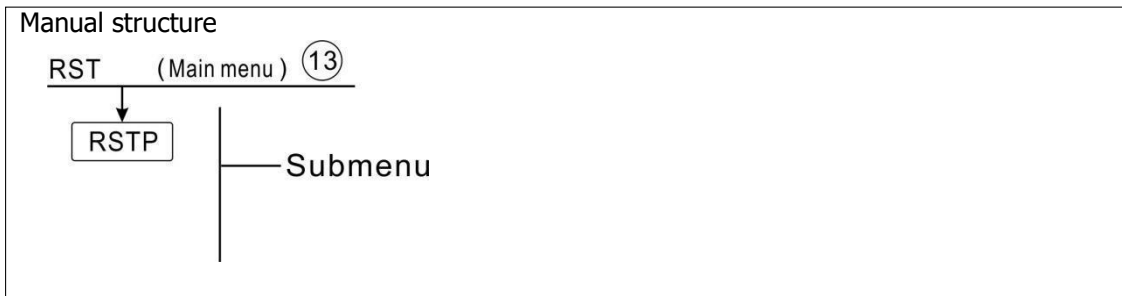

Function setting

- ▶ Select RST menu
- ▶ Press "SET", "RSTP" displays on the screen



- ▶ Press "SET", "YES" blinks
- ▶ Press "SET" for 3 seconds, beeper sounds "di" 3 times, "YES" lighting, and it indicates system is recovered to factory set.
- ▶ Press "ESC" return to the submenu
- ▶ Press "ESC" again, return to the main menu

8.12 PASS Password set



Function Setting

Select PASS main menu,

- ▶ Press "SET" button, "PWDN 0000" displays on the screen,
- 
- ▶ Press "SET" button again, the left first digital blinks, ask for entering the new password
 - ▶ Press "+/-" button, to enter the first digital.
 - ▶ Press "SET" button again, the second digital blinks,
 - ▶ Press "+/-" button, to enter the second digital.
 - ▶ Press "SET" button again, the third digital blinks,
 - ▶ Press "+/-" button, to enter the third digital.
 - ▶ Press "SET" button again, the fourth digital blinks,
 - ▶ Press "+/-" button, to enter the fourth digital.
 - ▶ Press "SET" button again, "PWDG 0000" displays on the screen, to enter the new password again, after confirm the new password, "OK" displays on the screen, it indicates the new password setting successfully.



Note: If the password is forgot, it is impossible to recover, but you can recover the password to factory set, then you can reedit a password like above descript steps, doing like following to recover to factory set.

- Switch-off the power to controller
- Hold down "ESC" button
- Reconnect the power supply, when beeper sounds 3 di di di, and then release "ESC" button, Controller recovers to the factory set password (factory set password is 0000),

8.13 Manual heating

Function Description:

It is possible to trigger back-up heating manually with this controller to heat tank. When tank temperature is lower than the set point of the switch-on temperature of this function, manual heating function is in standby, then when you press the manual heating button, heating will start, and it works until tank temperature reaches to the set point.

Activate/deactivate this function:

▶ Press "Manual Heating" button, temperature "60°C" blinks on the screen



▶ Press "+/-" button to adjust the desired temperature, adjustable range 10°C~80°C, factory set is 60°C

▶ Press "Manual Heating" or "ESC" or waiting for 20 seconds to trigger the manual heating, then manual sign (M) displays on the screen, heating sign (H) blinks the screen

▶ Press "Manual Heating" again, switch-off the manual heating.

i **Note:** Manual heating is not a continuous heating process, it is triggered manually, and when the temperature reaches to the set point, the heating process is stopped. And manual heating function is stopped automatically.

8.14 ECO Economic mode

Function description:

Under the ECO economic mode, timing heating and intelligent heating functions are switched-off, only manual heating mode (M.H) can be used to trigger the electrical heater.

Activate/deactivate this function:

▶ Press "ECO Mode" button, sign (E) displays, it





indicates Eco mode is on.

- ▶ Press "ECO Mode" button again, sign  closed, it indicates the ECO mode is off.



8.15 DHW circuit pump triggered manually

i **Note:** Only when function of DHW circuit pump CIRC is activated, it is just possible to trigger the output R2 manually for running the DHW circuit pump. (Default pump runs for 3 minutes)

- ▶ Press  "one time, to trigger the DHW circuit pump R2
- ▶ Press  "again, to cease the manual output.

8.16 On/Off controller

Under the on status

- ▶ Press  button for 3 seconds; controller is switched-off, "OFF" shows on the screen.
- ▶ Re-press  button again, controller restarted.



8.17 Holiday function

The holiday function is used for operating the system when no water consumption is expected, e. g. during a holiday absence. This function cools down the system in order to reduce the thermal load.

Activate/deactivate this function:

- ▶ Press "Holiday" button for 3 seconds, "HDAY 05" displays on the screen



- ▶ Press "+/-", to adjust holiday's days, adjustable range 0-99 days
- ▶ Press "ESC" to save set, holiday function is activated and holiday sign  displayed and lighted.
- ▶ After holiday function is activated, and then press "Holiday" button to cease this function, holiday sign  displayed but not lighted.

i **Note:** When you return from holiday, please deactivate this function in time.

8.18 Manual circuit function

- ▶ Press "Manual Circuit" button, circuit pump R1 is triggered and runs for 1 hour.
- ▶ Press "Manual Circuit" button, to switch- off the circuit pump R1.



During the running of circuit pump R1, if you don't press "Manual circuit" button, then R1 will run for 1 hour, then it is stopped automatically. And manual circuit function is deactivated correspondingly.

9. Protection function

9.1 Memory function during power failure

When power of controller is failed, and when power is switched-on, controller will keep the parameters which set before power failure.

9.2 Screen protection

When no any press on button for 5 minutes, screen protection is activated automatically, and then LED background lamp is switched-off. Through press any button to light LED lamp again.

10 Trouble checking

The built-in controller is a qualified product, which is conceived for years of continuous trouble-free operation. If a problem occurs, the most of causes is from the peripheral components but no relation with controller itself. The following description of some well-known problems should help the installer and operator to isolate the problem, so that the system can be put into operation as quickly as possible and to avoid unnecessary cost. Of course, not all possible problems can be listed here. However, most of the normal problems encountered with the controller can be found in the list below, only return the controller to seller when you are absolutely sure that none of the problems listed below is responsible for the fault.

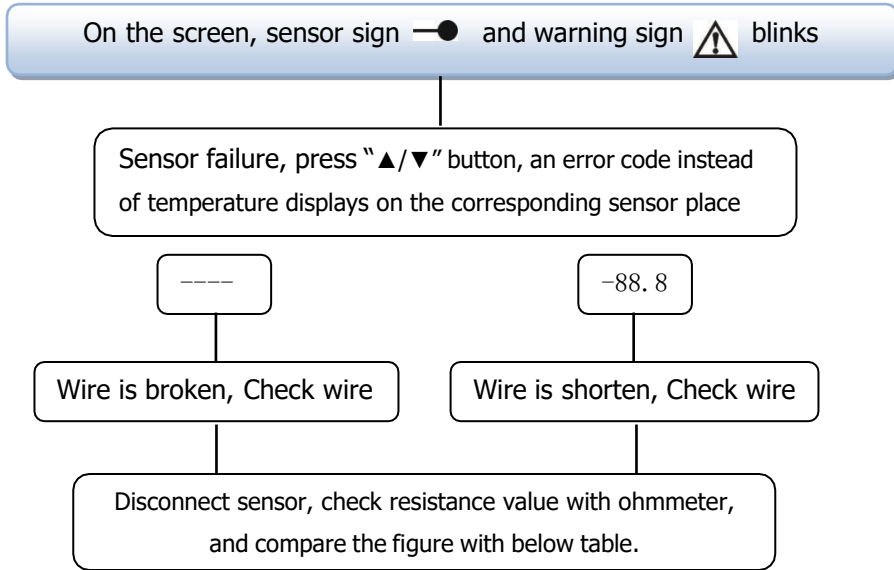

PT1000 resistance value

°C	0	10	20	30	40	50	60	70	80	90	100	110	120
Ω	1000	1039	1077	1116	1155	1194	1232	1270	1309	1347	1385	1422	1460

NTC 10K B=3950 resistance value

°C	0	10	20	30	40	50	60	70	80	90	100	110	120
Ω	33620	20174	12535	8037	5301	3588	2486	1759	1270	933	697	529	407

Error Code Explanation



No. of error code	Meaning	Reasons
E0	Communication error between display and main controller	1. White wire connection broken, or not connected reliably. 2. Communication error on display or on main controller

11. Quality Guarantee

Manufacturer provides following quality responsibilities to end-users: within the period of quality responsibilities, manufacturer will exclude the failure caused by production and material selection. A correct installation will not lead to failure. When a user takes incorrect handling way, incorrect installation, improper or crude handling, and wrong connection of Warm water outflow upwards, we don't take the responsibilities caused by before mentioned actions.

The quality warranty expires within 18 months after the date of purchasing the controller.

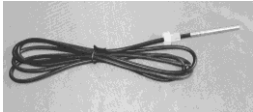
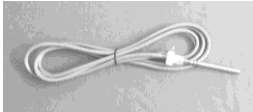
12. Accessories

Products name	Specification	Products picture
A01: High accurate Pt1000 sensor for collector	PT1000, $\Phi 6 \times 50\text{mm}$	
A02 High accurate sensor for tank and pipe	NTC10K, B=3950, $\Phi 6 \times 50\text{mm}$	
A05 304 stainless steel thermo well	304 stainless steel with thread 1/2' OT, Size: $\Phi 8 \times 200$	
Digital flow counter FRT (A17)	Connection: Male thread 3/4 Power: 5-24V/DC	

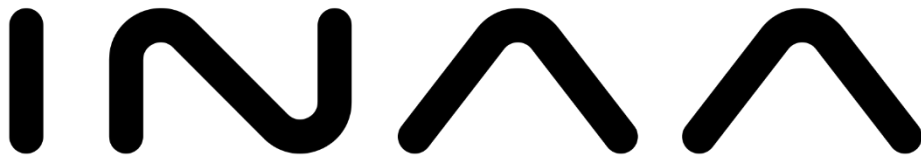

INSTALACIONES NATURALES ALTEA

Address: Polígono industrial Cotes Baixes C/G17,
03804. Alcoy (Alicante), España
Tel: (+34) 646420507
Website: www.inaa.es
e-mail: info@inaa.es